

DETAIL B
SCALE 1 : 1

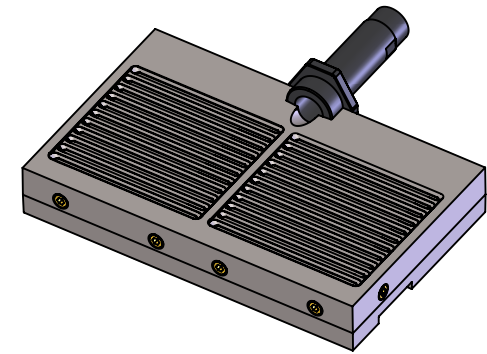

Stationary

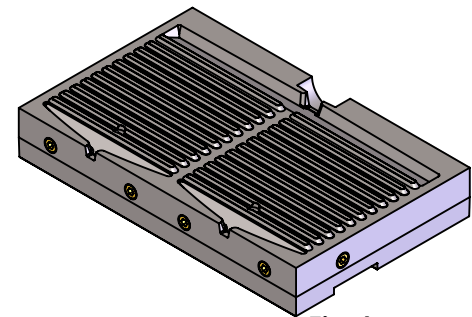
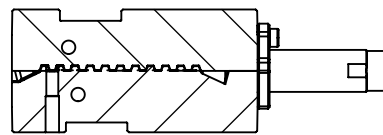
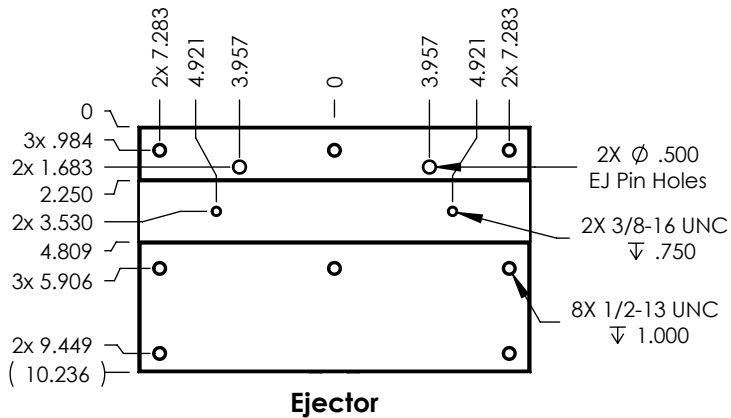
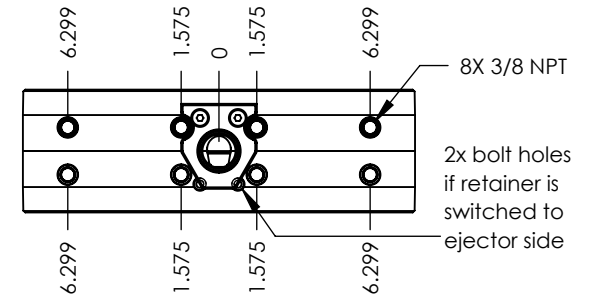
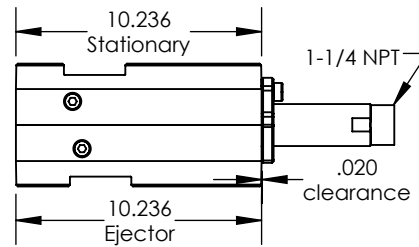
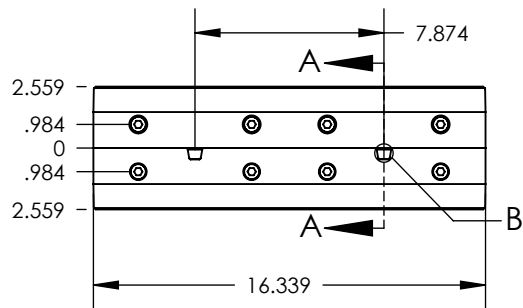

Ejector

Midland Technologies, Inc.

THE INFORMATION ON THIS DRAWING AND ASSOCIATED CAD MODEL IS THE SOLE PROPERTY OF MIDLAND TECHNOLOGIES, INC. ANY REPRODUCTION IN PART OR WHOLE WITHOUT WRITTEN PERMISSION OF MIDLAND TECHNOLOGIES, INC. IS PROHIBITED.

Standard Industry Tolerances Apply or:
ANGLE: ±1°
XX: ±.005 [-13]
XXX: ±.002 [-05]
.XXXX: ±.001 [-03]

MATL: H-13
HT: 44-46 Rc
FINISH:
UNLESS SPECIFIED:
ALL DIMENSIONS ARE IN INCHES [mm].
REMOVE BURS AND SHARP EDGES.
FILLET RADII AND EDGE BREAKS TO BE .005 TO .020.

TITLE: SV-16000 Full assembly

SIZE: A SCALE: 1:8
REV: A